

03.2009 TR30A064 RE

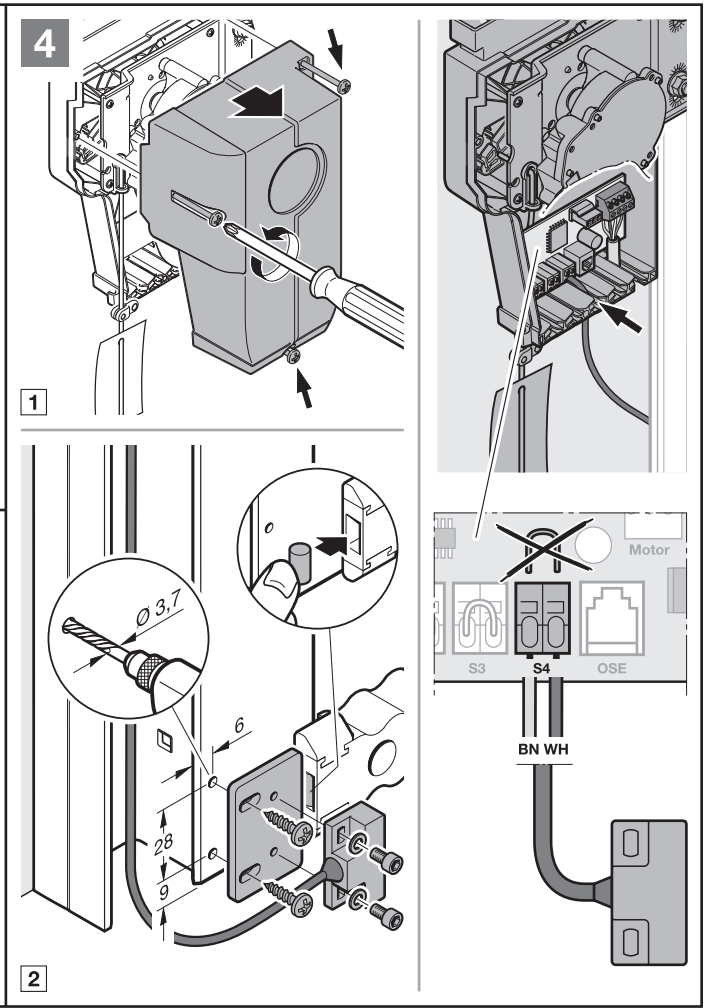

03.2009 TR30A064 RE

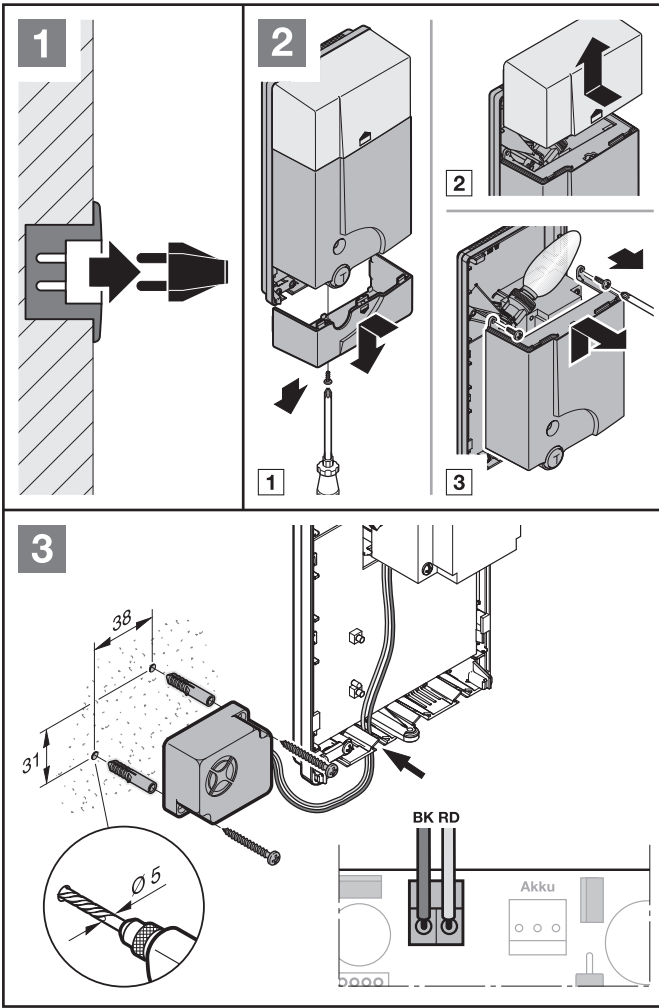